

Varenummer: 392206302453636  
 Beskrivelse: Snekkegear med skridnav  
 W63 L2-UFC-24-P90B14

## Mål

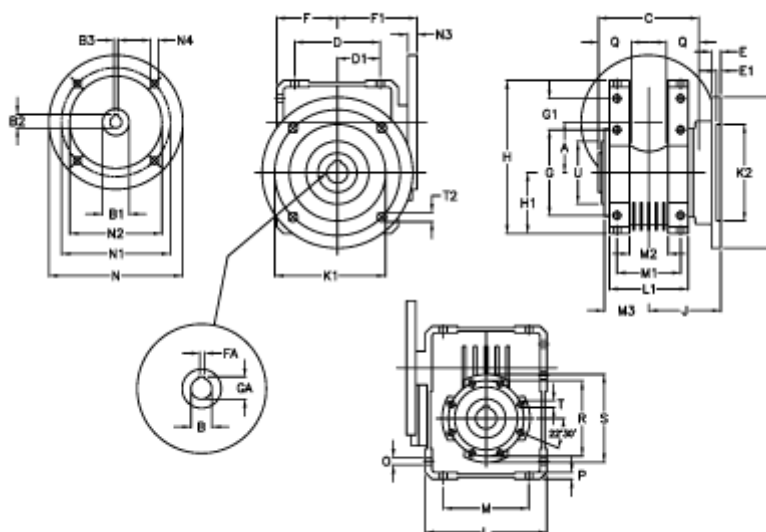

A = 62.17	E = 11	H = 182.5	M = 102	N4 = 8,5	U = 75
B = 25	E1 = 5	H1 = 72.5	M1 = 76	O = 9.0	
B1 E7 = 24	F = 73	J = 86.0	M2 = 46	P = 8	
B2 = 27.3	F1 = 102	K = 180	M3 = 53.0	Q = 35	
B3 H9 = 8	FA = 8	K1 = 150	N = 140	R = 90	
C = 120	G = 102	K2 = 115	N1 = 115	S = 105	
D = 102.0	G1 = 37.5	L = 145	N2 = 95	T = M8x14	
D1 = 51.0	GA = 28.3	L1 = 94	N3 = 11	T2 = 11.0	